

Visible APC Laser Module

APCD-650-07-05-A&B

6-2D-LM65-046 Rev.00

Φ3.3mm 650nm Laser Module

Features

APC (auto power control) IC inside
Low current consumption of the APC circuit
Much smaller LD module
Surge current protection
High quality lens for output beam



Absolute maximum ratings

Parameter	Symbol	Rating	Unit
Power supply voltage	V _{cc}	3.3	V
Laser Module optical output power	P _o	<5	mW
Operation temperature	T _{opr}	0~40	°C
Storage temperature	T _{stg}	0~60	°C

Electrical and optical characteristics (T_c=25 °C)

Parameter	Symbol	Min.	Typ.	Max.	Unit	Conditions
Wavelength	λ	-	655	-	nm	P _o = 5mW
Operation current	I _{op}	-	-	35	mA	P _o = 5mW ; V _{cc} =3V
Optical output power	P _{out}	3.7	-	5	mW	
Operation voltage	V _{op}	2.5	-	3.3	Volt	
Laser Beam spot size at 10m				<20mm		
Divergence angle				2 mrad		

* Sufficient heat dissipation is required for CW operation.

Outline dimensions (Units: mm)

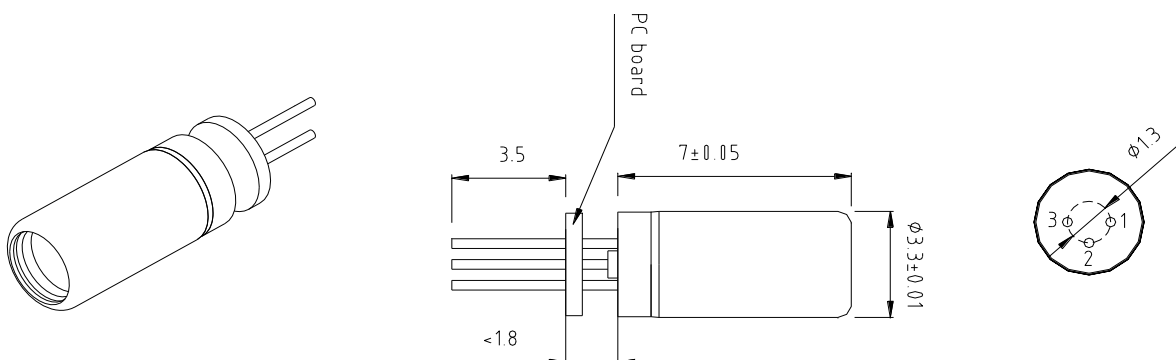

ARIMA LASERS CORP.

PHONE: 886-3-4699800 | FAX: 886-3-4699600

E-MAIL: Ldsales@arimalasers.com | www.arimalasers.com

For reference only. Contents above are subject to change without notice.

Arima
LASERS

Φ3.3mm 650nm Laser Module

Instruction manual

DC Power connection mode 1

A type : Heat sink stand (-)

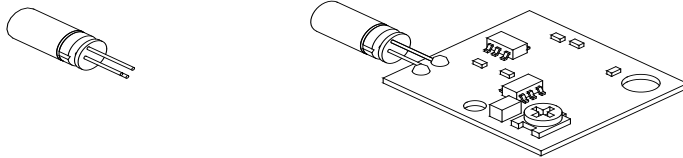
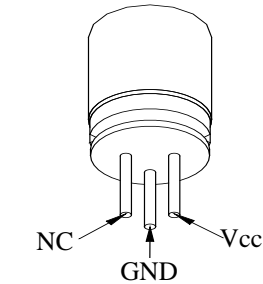

B type :Heat sink stand (+)

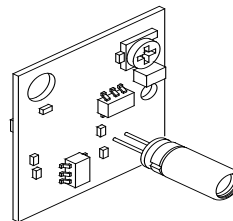
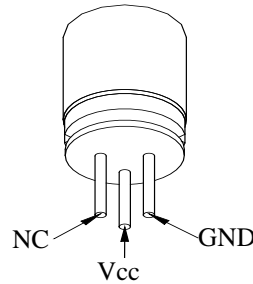

DC Power connection mode 2

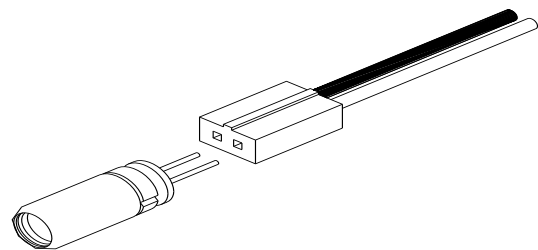
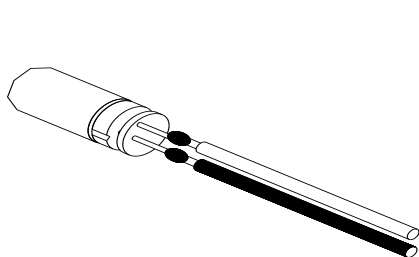
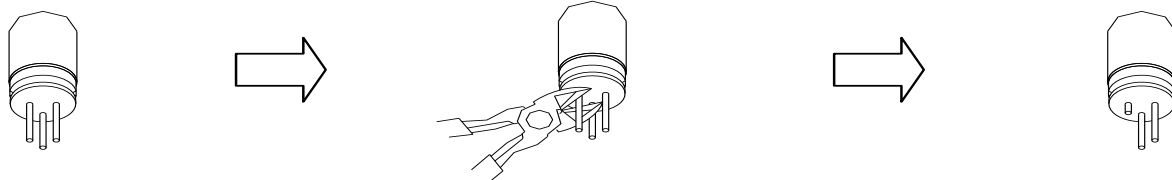

● Precautions

- * Do not operate the device above maximum ratings. Doing so may cause unexpected and permanent damage to the device.
- * Take precautions to avoid electrostatic discharge and/or momentary power spikes. A change in the characteristics of the laser or premature failure may result.
- * Proper heat sinking of the device assures stability and lifetime. Always ensure that maximum operating temperatures are not exceeded.
- * Observing visible or invisible laser beams with the human eye directly, or indirectly, can cause permanent damage. Use a camera to observe the laser.
- * No laser device should be used in any application or situation where life or property is at risk in event of device failure.
- * Specifications are subject to change without notice. Ensure that you have the latest specification by contacting us prior to purchase or use of the product.

ARIMA LASERS CORP.

PHONE: 886-3-4699800 | FAX: 886-3-4699600

E-MAIL: Ldsales@arimalasers.com | www.arimalasers.com

For reference only. Contents above are subject to change without notice.